

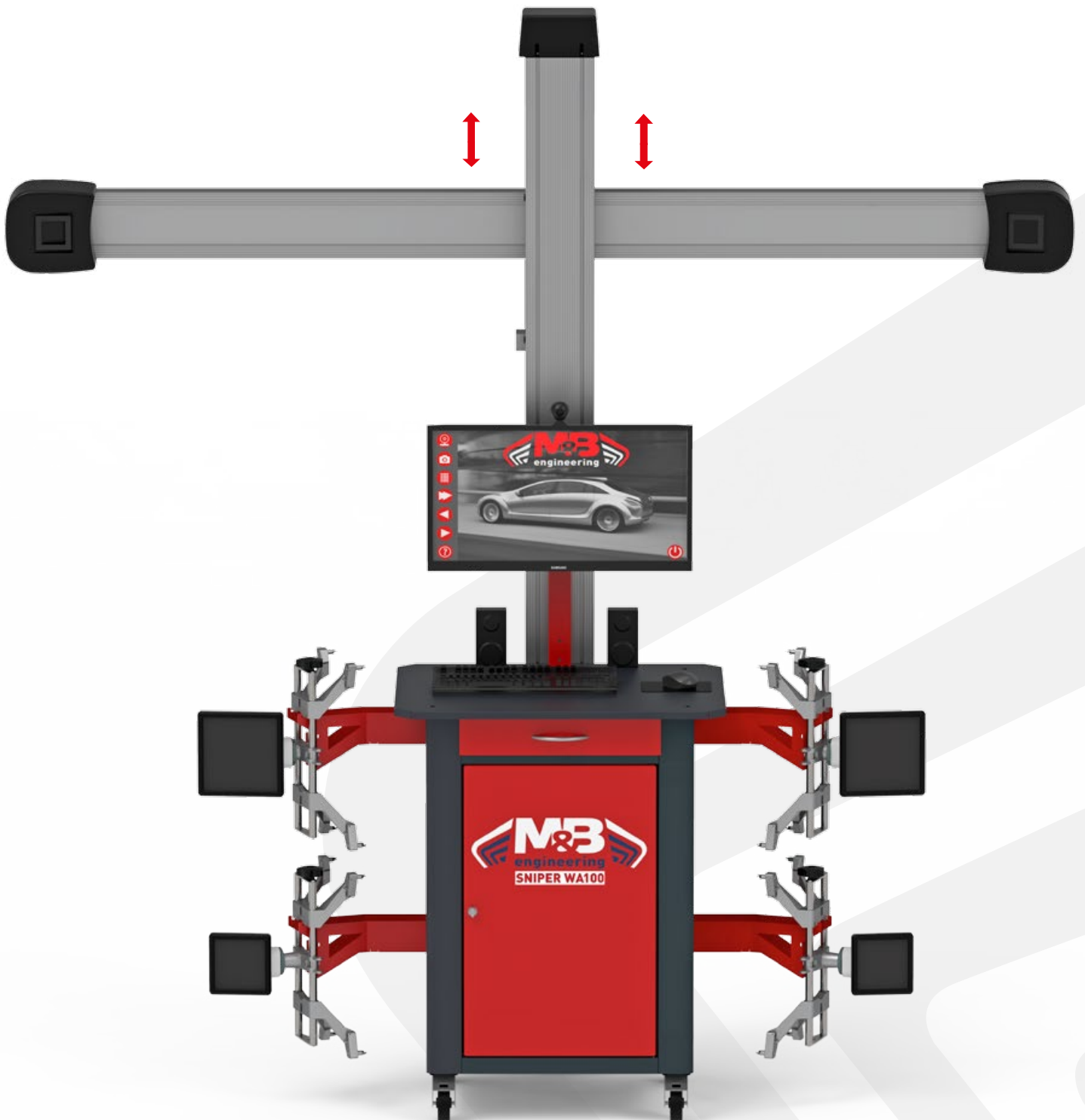

Sniper WA100

3D HD wheel alignment for maximum precision



Sniper WA100

- UK** **M&B SNIPER WA100** high-precision 3D wheel aligner, designed to ensure real-time reliable results thanks to fast and intuitive automation
- IT** **M&B SNIPER WA100** è l'assetto ruote 3D di alta precisione, studiato per garantire risultati affidabili in tempo reale grazie ad un'automazione rapida e intuitiva
- FR** **M&B SNIPER WA100** est l'alignement des roues 3D haute précision, imaginée pour garantir des résultats fiables en temps réel grâce à une automatisation rapide et intuitive
- DE** **M&B SNIPER WA100** ist eine hochpräzise 3D-Achsmessgerät, die dank einer schnellen und intuitiven Automatisierung zuverlässige Ergebnisse in Echtzeit gewährleistet
- ES** **M&B SNIPER WA100** es el alineamiento ruedas 3D de precisión elevada, estudiado para garantizar resultados de confianza en tiempo real gracias a una automatización rápida e intuitiva

FEATURES

- UK** **Mobile cameras: automatic adjustment** in the correct position according to the lift height
Full performance with wheelbase, track and diagonal, wheel diameter, caster angle and friction range measurements
Measurements with 2 targets for long vehicles
Single raised wheel run-out: useful in small spaces
Identification of driving problems, resulting from measures not contemplated in the specifications
User-friendly interface: using it and printing the final report are quick and easy
- IT** **Telecamere mobili: regolazione automatica** nella posizione corretta in base all'altezza del ponte
Prestazioni complete con misure di passo, carreggiata, diagonali, diametro ruote, braccio a terra e raggio d'attrito
Misura con 2 targets in caso di veicoli lunghi
Run-out a ruota singola sollevata: utile in mancanza di spazio
Diagnosi dei disturbi di guida conseguenti a misure rilevate fuori specifica
Interfaccia intuitiva: l'utilizzo e la stampa del report finale sono facili e veloci
- FR** **Caméras mobiles : réglage automatique** dans la position correcte en fonction de la hauteur de l'élévateur
Performances complètes avec mesures de pas, largeur et diagonales, du diamètre des roues, de bras à terre et rayon de frottement
Mesure avec 2 cibles pour les véhicules longs
Mesure de l'excentricité à roue indépendante soulevée utile en manque d'espace
Diagnostic des problèmes de conduite à la suite de mesures hors spécification
Interface intuitive : l'utilisation ainsi que l'impression du rapport final sont rapides et faciles
- DE** **Mobile Kameras: Automatische Einstellung** in der richtigen Position auf der Grundlage der Brückenhöhe
Volle Leistungen mit Messung von Radstand, Spurweite und Diagonalen, des Raddurchmessers, von Caster und Reibungsradius
Messung mit 2 Zielscheiben für lange Fahrzeuge
Run-out am einzelnen angehobenen Rad nützlich bei Platzmangel
Die Diagnose der Fahrstörungen infolge von Messungen außerhalb der Toleranz
Intuitive Benutzeroberfläche: Die Verwendung und das Drucken des Abschlussberichts sind schnell und einfach
- ES** **Telecámaras móviles: ajuste automático** en posición correcta de acuerdo con la altura del elevador
Prestaciones completas con medida de paso, superficie de rodadura, diagonales, del diámetro de las ruedas, de brazo en el suelo y radio de rozamiento
Medida con 2 puntos de referencia en vehículos largos
Desviación con una rueda levantada útil si falta espacio
Diagnóstico de problemas de conducción debidos a medidas que no cumplen las especificaciones
Interfaz intuitiva: el uso y la impresión del informe final son rápidos y fáciles

DURABLE TARGETS

- UK** **Targets with reduced dimensions;** no electronic components
- IT** **Bersagli di dimensioni ridotte;** nessun componente elettronico
- FR** **Cibles compactes;** pas de composants électroniques
- DE** **Kompakte Zielscheiben;** Keine elektronischen Komponenten
- ES** **Objetivos compactos;** ningún componentes electrónicos



3D HD wheel alignment for maximum precision

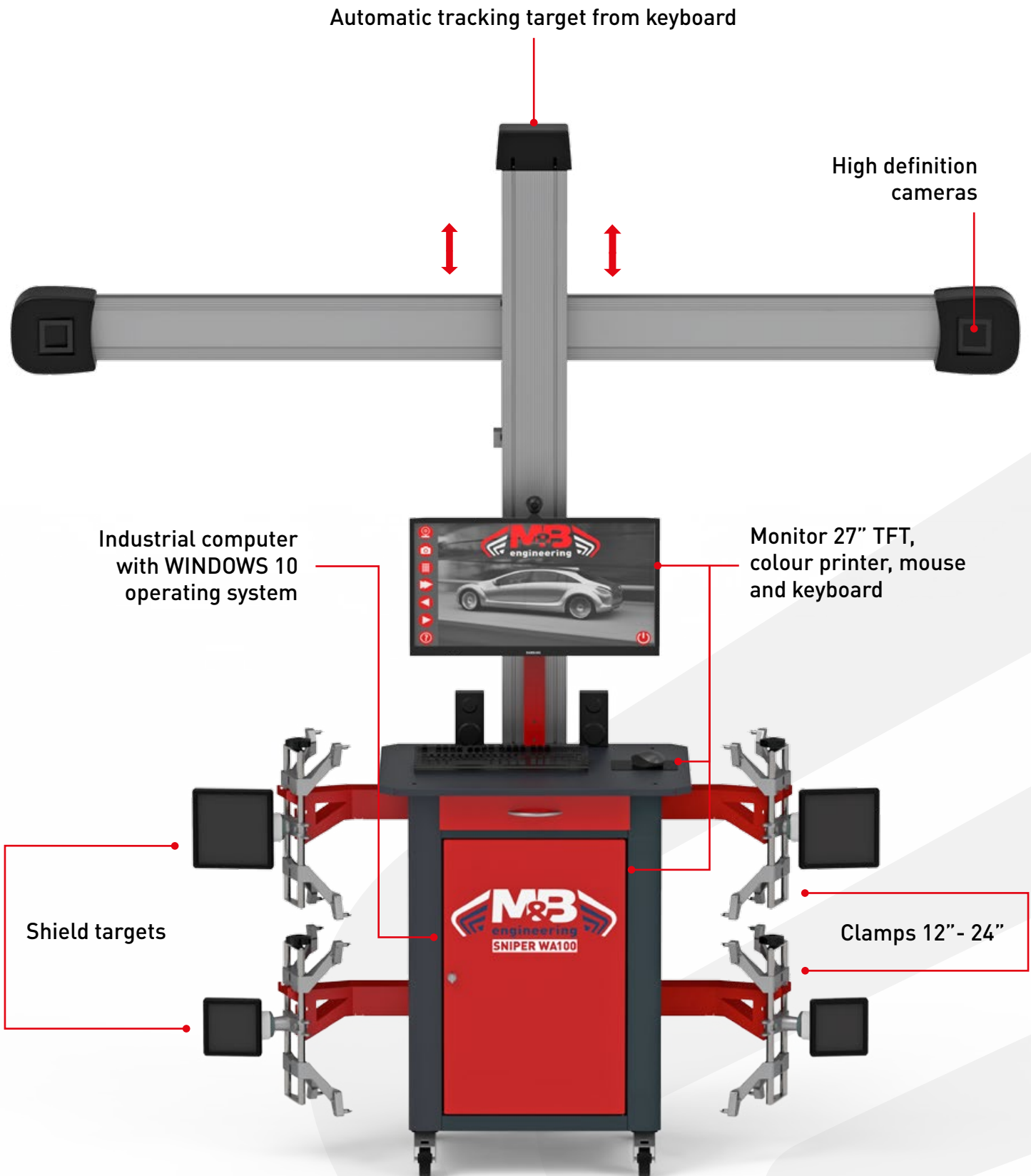

STANDARD CONFIGURATION











-  Four self-centering clamps 12"-24" with universal grips
Brake pedal, steering wheel holder, two wedge blocks
Two mechanical turning plates
-  Quattro aggrappi autocentranti 12"-24"
con unghiette universali
Premipedale, bloccasterzo, due tamponi
Coppia di piatti rotanti meccanici
-  Quatre griffes à 4 points 12"-24" avec ongles universels
Presseur pédale, blocage direction, tampons
Deux plateaux pivotants mécaniques
-  4 Radklammern mit 4 Kontaktpunkten (12-24") mit
Universalradklammerfingern
Pedalbetätigung, Lenkradfeststeller, Tumpfers
Zwei mechanische Drehplatten
-  Cuatro garras de 4 puntos de 12-24"
con uñas universales
Bloqueo de volante, depresor de freno,
almohadillas
Dos placas giratorias mecánicas



Optional up to 27"

OPTIONAL ACCESSORIES



-  Premium turntables: two mechanical
turntables and two paddles to ease
the run-out operations
-  Piatti Premium: due piatti rotanti
e due supporti in gomma per
agevolare la manovra a spinta
-  Plateaux Premium : deux plateaux
et deux entretoises caoutchouc pour
une manoeuvre de pousse aisée
-  Premium-Teller: 2 Drehtellern und
2 Gummiträgern für erleichterten
Run-out-Vorgang
-  Platos Premium: dos platos giratorios
y dos espaciadores de plástico para
agilizar la manidora de alabeo
-  Frontal assistance webcam
-  Videocamera frontale
-  Caméra vidéo frontale d'aide
-  Vordere Hilfs-Videokamera
-  Videocámara delantera de ayuda

