



DIDO XXL-L

**SUPER-AUTOMATIC TYRE CHANGER FOR TRUCK,
BUS AND OTR WHEELS UP TO 60"**



DIDO XXL-L SUPER-AUTOMATIC TYRE CHANGER FOR TRUCK, BUS AND OTR WHEELS UP TO 60"



Universal 4-jaw hydraulic self-centering chuck

The bead breaker disc is always perfectly aligned with the rim



Radio-controlled operation



Low voltage portable control unit



Innovative "TOOLS ALWAYS IN LINE" working technology: disc and tool are always in optimum working position relative to the rim





AVAILABLE VERSIONS







VIA CABLE TRANSMISSION



VIA RADIO TRANSMISSION

-  **M&B DIDO XXL-L** is the super-automatic electro-hydraulic tyre changer with double reinforced frame designed for truck, bus, agricultural vehicle and earthmover wheel.
-  **M&B DIDO XXL-L** è lo smontagomme elettroidraulico superautomatico con telaio rinforzato progettato per operare su pneumatici da autocarro, bus, veicoli da agricoltura e macchine movimento terra.
-  **M&B DIDO XXL-L** est le démonte-pneus électro-hydraulique super automatique avec châssis double renforcé idéal pour les ateliers au service du pneu pour le démontage et le montage de pneus PL, bus, machines agricoles et génie civil.
-  **M&B DIDO XXL-L** ist die superautomatische hydraulische Reifenmontiermaschine mit doppelt verstärktem Rahmen ideal für Reifenservicebetriebe zur Demontage und Montage von Reifen für Lkw, Busse, landwirtschaftliche Fahrzeuge und Erdbewegungsmaschinen.
-  **M&B DIDO XXL-L** es la desmontadora súperautomática electrohidráulica con doble chasis reforzad para el desmontaje de neumáticos de camiones, autobuses, vehículos agrícolas y ruedas de maquinaria para el movimiento de tierras.

-  **Synchronized carriages movement.** Designed with "ALWAYS IN TANGENCE" technology, disc and tool are always in the correct position, tangent at the edge of the rim, to ensure rapid operations and safeguard both the tyre and the rim.
Universal 4-jaw hydraulic self-centering chuck, developed to clamp all types of rims from 14" to 42" (up to 60" using the optional extensions). The jaws has 5 clamping points to ensure an optimal clamping of any type of rim. The spindle has two rotation speeds in both direction. Central hole minimum diameter clamp: 115 mm.
Fully automatic tool arm, both in lifting and in rotation. Possibility to operate with a free disc (not locked); in this way, the disc is always in the optimal working position, with less effort for the operator and faster in execution.
-  **Movimentazione sincronizzata dei carrelli.** Progettato con la tecnologia "SEMPRE IN TANGENZA" il disco ed l'unghia sono sempre nella corretta posizione, tangenti al bordo del cerchio, per garantire rapidità delle operazioni e salvaguardia sia dello pneumatico che del cerchio.
Autocentrante universale idraulico a 4 griffe, disegnato per bloccare tutti i tipi di cerchi da 14"÷ 42" (fino a 60" utilizzando le prolunghie in opzione). La griffa ha 5 prese di bloccaggio per garantire un serraggio ottimale su qualsiasi tipo di cerchio. Il mandrino ha due velocità per entrambi i sensi di rotazione. Presa diametro minimo foro centrale: 115 mm.
Braccio porta utensili completamente automatico sia in sollevamento che in rotazione. Possibilità di operare con disco libero (non bloccato); in questo modo il disco si trova sempre nella posizione ottimale di lavoro, con minore sforzo per l'operatore e maggiore rapidità di esecuzione.
-  **Mouvement de chariot synchronisé.** Conçu avec la technologie "TOUJOURS EN TANGENCE", le disque et le clou sont toujours dans la bonne position, tangent au bord de la jante, pour assurer un fonctionnement rapide et protéger à la fois le pneu et la jante.
Mandrin hydraulique autocentrant universel à 4 mors, développé pour serrer tous les types de jantes de 14" à 42" (jusqu'à 60" en utilisant les rallonge sur demande). Les griffes ont 5 points de serrage pour assurer un serrage optimal de tout type de jante. Deux vitesses de rotation dans les deux sens. Prise de diamètre minimum du trou central: 115 mm.
Bras porte-outils entièrement automatique en levage et en rotation. Possibilité de travailler avec le disque libre (non bloqué), de cette façon le disque est toujours dans la position de travail optimale, pour assurer un serrage optimal de tout type de jante avec moins d'effort pour l'opérateur et plus vitesse de travaille.
-  **Synchron verfahrenre Montageschlitten Spannfutter und Werkzeug arbeiten immer in derselben Ebene** und sorgen so dafür, dass sich Abdrückrolle und Montierhaken immer in der richtigen Position tangential zum Felgenhorn befinden. Dies gewährleistet nicht nur eine schnelle Bearbeitung, sondern schon sowohl den Reifen als auch die Felge.
Selbstzentrierendes hydraulisches **Universal-Spannfutter mit 4 Spannklauen** zum Einspannen aller Felgengrößen von 14" bis 42" (bis zu 60" bei Verwendung der optional erhältlichen Spannklauenverlängerungen). Spannklauen mit 5 Spannaufnahmen garantieren ein optimales Aufspannen von Felgen beliebiger Art. Spindel mit zwei Geschwindigkeitstufen in beiden Laufrichtungen. Aufnahmedurchmesser Mittelbohrung min. 115 mm.
Vollautomatischer Werkzeugarm (sowohl Heben als auch Drehen). Betriebsmöglichkeit mit unverriegelter Abdrückrolle: auf diese Weise befindet sich die Rolle immer in der optimalen Arbeitsposition und sorgt so für weniger Kraftaufwand beim Bediener und eine schnellere Bearbeitung.
-  **Movimiento sincronizado de los carros.** Diseñado con la tecnología de trabajo "SIEMPRE EN TANGENCIA", el disco y el utensilio están siempre en la posición correcta, tangente en el borde de la llanta, para garantizar operaciones rápidas y proteger tanto el neumático como la llanta.
Autocentrante universal hidráulico de 4 mordazas, desarrollado para bloquear todo tipo de llantas con capacidad de 14" hasta 42" (hasta 60" utilizando las extensiones opcionales). Las mordazas tienen 5 puntos de sujeción para garantizar una sujeción óptima de cualquier tipo de llanta. Dos velocidades para cada sentido de rotación. Bloqueo diámetro mínimo central: 115 mm.
Brazo portaherramientas totalmente automático tanto en elevación como en rotación. Posibilidad de operar con un disco libre (no bloqueado), de esta manera el disco está siempre en la posición óptima de trabajo, con menos esfuerzo para el operador y una ejecución más rápida.

STANDARD CONFIGURATION



OPTIONAL ACCESSORIES

4 Aluminium jaws protections	Pneumatic bead pressing tool	4 clamping extension	Caterpillar clamping adaptors kit	Adaptor for internal hole 100 mm (1pc)
LL cylinder	ALU ring protection rim 281 mm for 22,5	ALU ring protection 220 mm	ALU ring protection 201 mm	ALU ring protection 175 mm

OVERALL DIMENSIONS

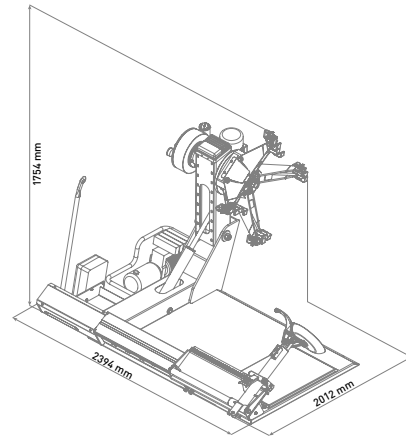
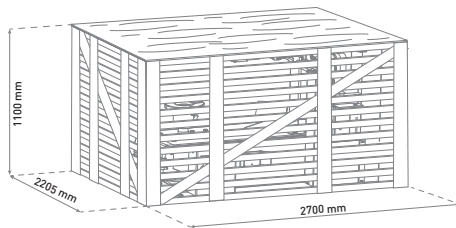

TECHNICAL DATA

1550 kg	14" - 42" [14" - 60" ext.]	10" ÷ 30" 265 ÷ 765 mm	59" 1500 mm	106" 2700 mm	2500 kg	30000 N 273 kg	400/3/50-60 Hz 230/3/50-60 Hz	4.5 - 9 rpm	2.2 - 3



M&B ENGINEERING SRL
Via Nobel, 21 - 42124 Reggio Emilia (RE)
info@mb-re.it - www.mbenengineering.info